

The background of the page is filled with technical line drawings of various window glazing components, including seals, tapes, and setting blocks. Some components are highlighted with red circles. The company logo is centered at the top.

Reed Rubber

P R O D U C T S

Rubber Glazing Components Catalog

Effective January 2020

Glazing seals, tapes,
and setting blocks



314-450-4789

Table of Contents

Storefront gaskets	1-4
Curtainwall gaskets	5-6
Top Bead Spacers wedges and presets	7
Glazing components for common Storefront systems	8
Glazing pocket details	9
Setting Blocks	10-11
Glazing tape	12
Popular glazing system combinations	13-14



314-450-4789





VOLUME DISCOUNTS
 Effective February 1st, 2011

\$2000 order*
3% discount

\$5000 order*
6% discount

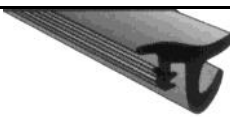
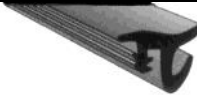
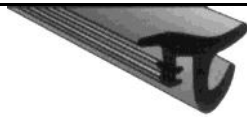
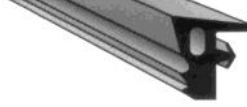
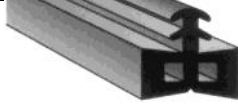
*Products can be combined to achieve discount

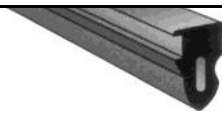
Storefront Gaskets

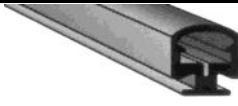
Reed Part #	Profile Not to scale	Conversion Part #	Ft./box	Price/ft	Price/box
3678		Kawneer 27-074	500	.160	80.00
3679		Kawneer 27-076	500	.162	81.00
3680		Kawneer 27-077	500 (Minimum Order 5,000)	.218	109.00
3681		Kawneer 27-850	400	.320	128.00
3683		Kawneer 162-310	250*	.379	94.75
3684		Kawneer 27-857	500*	.224	112.00
3661		Kawneer 27-810	1,000	.190	190.00
3662		Kawneer 27-807	500 (Minimum Order 5,000)	.140	70.00
3663		Kawneer 27-808	500 (Minimum Order 5,000)	.350	175.00

*Check availability at time of order



314-450-4789



VOLUME DISCOUNTS
 Effective February 1st, 2011

\$2000 order*
3% discount

\$5000 order*
6% discount

*Products can be combined to achieve discount

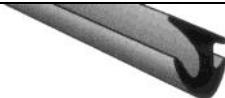
Storefront Gaskets

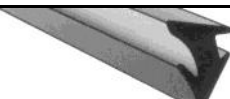
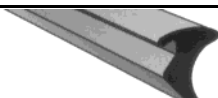
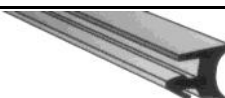
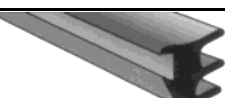
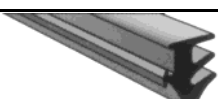
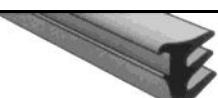
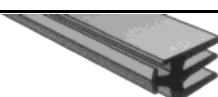
Reed Part #	Profile Not to scale	Conversion Part #	Ft./box	Price/ft	Price/box
3654		Kawneer 27-222	1,000	.151	151.00
3656		Kawneer 27-285	1,000	.151	151.00
3657		Kawneer 27-200	500	.208	104.00
3730		Kawneer 27-221	1,000	.128	128.00
3731		Kawneer 27-223	1,000	.133	133.00
3696		Amarlite 05429	500	.185	92.50
3697		Amarlite 05430	500	.185	92.50
3698		Amarlite 05421	500	.156	78.00
3699		Amarlite 05212	500 (Minimum Order 5,000)	.200	100



314-450-4789







VOLUME DISCOUNTS
 Effective February 1st, 2011

\$2000 order*
3% discount

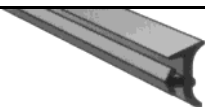
\$5000 order*
6% discount

*Products can be combined to achieve discount

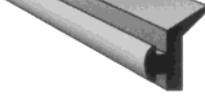
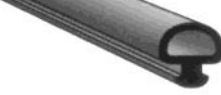
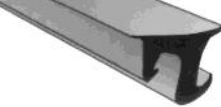
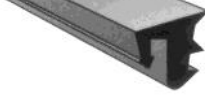
Storefront Gaskets

Reed Part #	Profile Not to scale	Conversion Part #	Ft./box	Price/ft	Price/box
3737		US Alum. NP-150	1,000	.200	200.00
3738		US Alum. NP-260	1,000	.130	130.00
3686		US Alum. NP-225	500	.260	130.00
3734		Atlas 90	500 (Minimum Order 2,500)	.240	120.00
3735		Atlas 67	1,000	.145	145.00
3694		Tubelite P-302	1,000	.104	104.00
3695		Tubelite P-528	500	.270	135.00
4893		Vistawall FG-1133	500	.190	95.00
3736		PPG 17-004-6300	500	.250	125.00



314-450-4789



VOLUME DISCOUNTS
 Effective February 1st, 2011

\$2000 order*
3% discount

\$5000 order*
6% discount

*Products can be combined to achieve discount

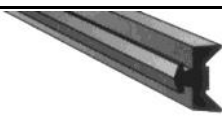
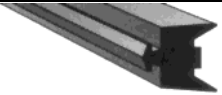
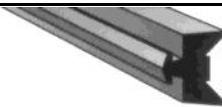
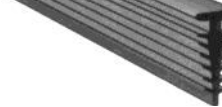
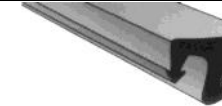
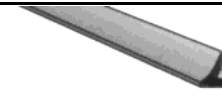
Storefront Gaskets

Reed Part #	Profile Not to scale	Conversion Part #	Ft./box	Price/ft	Price/box
4001		Bonnell BTF-1400	1000	.130	130.00
4002		Bonnell BTF-1400	500 (Minimum Order 2,500)	.350	175.00
4004		Bonnell BTF-1400	1,000 (Minimum Order 5,000)	.187	187.00
4990		Vision Strip	1,000 (Minimum Order 5,000)	.156	156.00
4020		YKK E2-0052	500	.192	96.00
4157		Elward 138G	2,000 (Minimum Order 10,000)	.083	166.00
1152		Pivot Window Wipe	500 (Minimum Order 5,000)	.187	93.50

Don't see the gasket you need?

We offer custom profiles manufactured in single, dual and tri-durometers. Glazing Gaskets are available in colors.

We can also extrude a thin "slip coat" layer to make the gasket easier to apply. Call us for details!



314-450-4789

VOLUME DISCOUNTS
 Effective February 1st, 2011

\$2000 order*
3% discount

\$5000 order*
6% discount

*Products can be combined to achieve discount

Curtainwall Gaskets

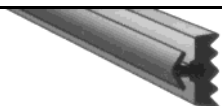
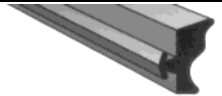
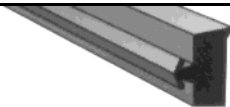
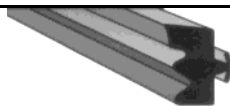
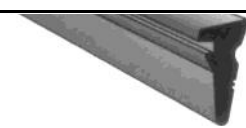
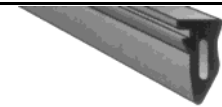
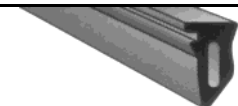
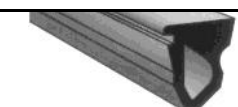
Reed Part #	Profile Not to scale	Critical Dimensions	Ft./box	Price/ft	Price/Box
B090 (sponge)		.125 face clearance, .250 centerline	500	.140	70.00
B109 (sponge)		.150 face clearance .250 centerline	500	.144	72.00
B116		PPG 70-810-6300 .200 face clearance .250 centerline	500	.205	102.50
B140 (sponge)		.250 face clearance .250 centerline	500	.203	101.50
W513		.125 face clearance .062 nub	1,000	.130	130.00
W514		.187 face clearance .062 nub	500	.140	70.00
W516		.250 face clearance .062 nub	500	.225	112.50
W520		.350 face clearance .062 nub	500	.360	180.00



314-450-4789

VOLUME DISCOUNTS
Effective February 1st, 2011

\$2000 order*
3% discount

\$5000 order*
6% discount

*Products can be combined to achieve discount

Curtainwall Gaskets

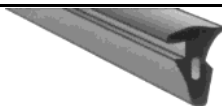
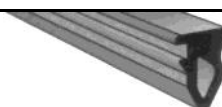
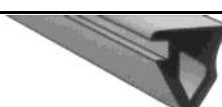
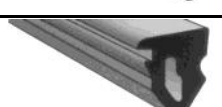
Reed Part #	Profile <small>Not to scale</small>	Critical Dimensions	Ft./box	Price/ft	Price/box
W190		.187 face clearance .125 nub	500	.145	72.50
W250		.250 face clearance .125 nub	500	.230	115.00
W315		.312 face clearance .125 nub	500	.357	178.50
W375		.375 face clearance .100 nub	500	.365	182.50

Don't see the gasket you need?

We offer custom profiles manufactured in single, dual and tri-durometers. Glazing Gaskets are available in colors.

We can also extrude a thin "slip coat" layer to make the gasket easier to apply. Call us for details!



314-450-4789

VOLUME DISCOUNTS
 Effective February 1st, 2011

\$2000 order*
3% discount

\$5000 order*
6% discount

*Products can be combined to achieve discount

Top Bead Spacers Wedges and Presets

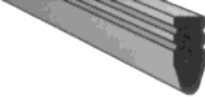
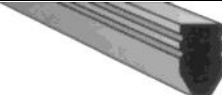
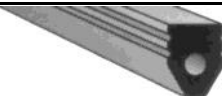
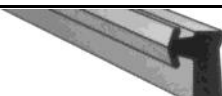
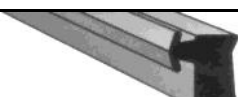
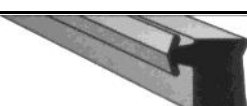
Reed Part #	Profile Not to scale	Critical Dimensions	Ft./box	Price/ft	Price/box
SW125		.125 Face clearance	1,000	.140	140.00
SW187		.187 face clearance	1,000	.260	260.00
SW250		.250 face clearance	1,000	.301	301.00
SP125		.125 face clearance	1,000 (Minimum Order 4,000)	.200	200.00
SP187		.187 face clearance	500 (Minimum Order 4,000)	.230	115.00
SP250		.250 face clearance	500 (Minimum Order 2,500)	.400	200.00

Available in colors
 and
 custom made to your specifications



Phone: 314-450-4789
Fax: 314-450-4777
www.reedruberproducts.com

Bonnell Metal Systems

This section lists the common storefront metal systems produced by Wm. L. Bonnell Co.

BONNELL METAL SYSTEM	REED RUBBER PRODUCTS COMPONENTS
SD-30 (BTF-300, 450, 600)	3654 roll-in with 1/4" x 1/2" glazing tape 4005 mullion "U" channel, 4006 wiper gasket
SD-49 (BCE-250)	B116 exterior preset with B-1 15 interior preset. Alternate: B140 both sides.
SD-53 (BCE-850)	3654 roll-in with 3733 preset.
SD-58 (BCE-200)	B109 both interior and exterior with 3999 thermal separator.
SD-59 (A-9200)	3654 roll-in with 3656 preset.
SD-62 (BCE-1300)	3694 bead or exterior, 3739 fixed or interior.
SD-66 (BTF-700)	3734 both sides/head and sill with RU5100 mullion spacer tape.
SD-67 (BCE-100)	3730 roll-in with 3733 preset.
SD-71 (BCE-20)	3694 bulb seal on both sides.
SD-72 (BCE, 470, 480, 490)	3735 on both sides.
SD-102 (BCE-400)	3734 or 4893 both sides
SD-103 (BCE-450)	3734 or 4893 both sides
SO-104 (BCE-1400)	3734 or 4893 both sides
SD-106 (BCE-1450, 5450, 6450)	3734 or 4893 both sides
SD-120 (BTF-1400)	3654 roll-in, 4001 preset (horizontal) 4002, 4005, 4006 & 4007(vertical)
SD-118 (BCE-1100, 1150, 2150)	3696 roll-in with 3697 preset
SD-127 (BTF-2400)	3734 or 4893 both sides
SD-128 (BTF-1700)	3667 both sides
SD-129 (BCE-1850,-9200 BTF-1850)	3678 both sides, 3679 for oversized glass/3680 for undersized glass.
SD-139 (BCE-4000, -4500)	3695 both sides
SD-142 (BCE-1200,-2200)	1596 both sides
SD-156 (BCE-6200)	3654 & 3656

Keymark Metal Systems

This section lists the common storefront metal systems produced by Keymark Aluminum.

KEYMARK METAL SYSTEM	REED RUBBER COMPONENTS
PW251	3674 (interior) 3675 (exterior) 1447 thermal separator
450	3678 both sides



Phone: 314-450-4789
 Fax: 314-450-4777
www.reedrubberrubberproducts.com

Suggested Glazing Pocket Details

What is the *nub dimension*? In order for the wedge to fit properly and lock into the metal, we will need to know this critical dimension on your metal. Here are some typical nubs:

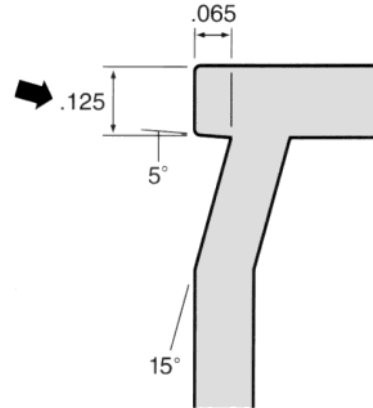
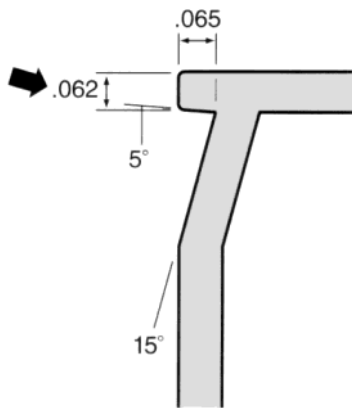

What is *face clearance*? Face clearance is the distance between the glass and the metal that our wedge or preset fills in a compressed state.

Here is an example:

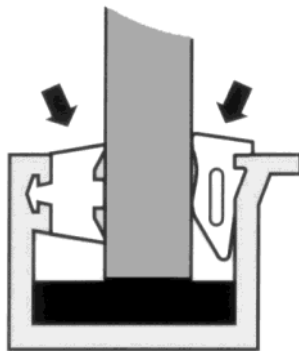

What is *centerline*? This dimension when associated with presets, measures from the center of the dart and race to the top of the metal.

Here is an example:

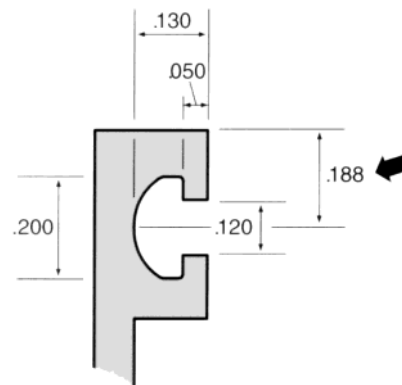

Durometer: This is the relative hardness of rubber as typically measured on the Shore A Scale for dense rubber. Generally Storefront Rubber falls in the 65-70 durometer range while setting block are 85 +/- 5 durometer.



Phone: 314-450-4789
Fax: 314-450-4777
www.reedrubberproducts.com

Setting Blocks

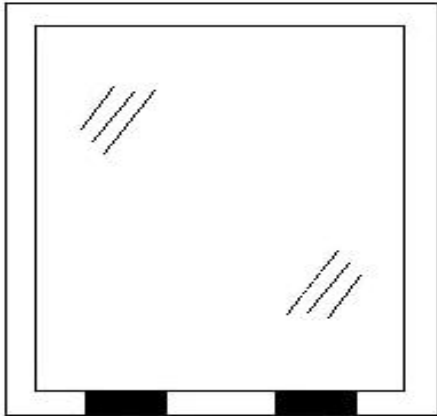

Setting Blocks centered at 1/4 points of glass.

Suggested Block Length per block:
.1" per sq. ft. glass area but never less than 4"
if glass width is greater than 48"

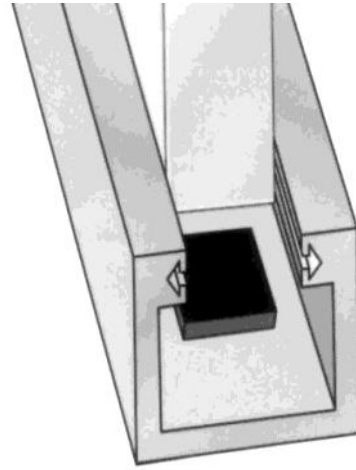

Neoprene Setting Blocks
**See next page for pricing and availability*

TPV Setting Blocks

Are frequently used with Lexan in Security Glazing, Photovoltaic Solar panels and other composite glass applications. Our TPV Setting Blocks are compatible with Lexan and will not cause crazing.

**Please call for pricing and availability*

VOLUME DISCOUNTS
Effective February 1st, 2011

\$2000 order*
3% discount

\$5000 order*
6% discount

**Products can be combined to achieve discount*



Phone: 314-450-4789
 Fax: 314-450-4777
www.reedrubberproducts.com

80 - 85 Durometer Neoprene Setting Blocks

Size (in.)	Reed Part #	Qty/box	Price/each	Price/box
1/16" thick				
1/16 x 1 x 4	BN01164	1000	.070	70.00
1/16 x 1-1/8 x 4	BN01184	1000	.090	90.00
1/8" thick				
1/8 x 1 x 2	BN02162	1000	.060	60.00
1/8 x 1 x 4	BN02164	1000	.110	110.00
1/8 x 1-1/8 x 4	BN02184	1000	.145	145.00
1/4" thick				
1/4 x 1/2 x 2	BN04082	2000	.085	170.00
1/4 x 1 x 2	BN04162	1000	.120	120.00
1/4 x 1 x 4	BN04164	500	.245	122.50
1/4 x 1-1/8 x 4	BN04184	500	.270	135.00
3/8" thick				
3/8 x 1/2 x 2	BN06082	500	.110	55.00
3/8 x 1/2 x 4	BN06084	500	.210	105.00
1/2" thick				
1/2 x 1 x 2	BN08162	500	.320	160.00
1/2 x 1 x 4	BN08164	250	.530	132.50

Other sizes available, subject to a \$500 minimum and 2 week lead time

VOLUME DISCOUNTS
 Effective February 1st, 2011

\$2000 order*
 3% discount

\$5000 order*
 6% discount

*Products can be combined to achieve discount



Phone: 314-450-4789
 Fax: 314-450-4777
www.reedrubberproducts.com

Reedseal Glazing Tape

Reedseal black cross-linked polyethylene glazing tape meets requirements for AAMA 810.1 Type 1.

Reedseal has solvent based acrylic pressure sensitive adhesive on both sides for quick tack and long lasting adhesion.

Reedseal is very conformable and will adhere to a wide variety of surfaces making it an excellent material to seal out air and moisture in glazing applications.



Part Number	Thickness/Width/Length	Ft./box	Price/ft	Price/box
TY04-01062B	1/16" x 3/8" x 185'	7,400	.045	333.00
TY04-01082B	1/16" x 1/2" x 185'	5,550	.061	338.55
TY04-02062B	1/8" x 3/8" x 75'	3,000	.074	222.00
TY04-02082B	1/8" x 1/2" x 75'	2,250	.095	213.75

***Please Call for pricing and lead time for sizes not listed above

VOLUME DISCOUNTS Effective February 1st, 2011	\$2000 order* 3% discount \$5000 order* 6% discount
<small>*Products can be combined to achieve discount</small>	



Phone: 314-450-4789
Fax: 314-450-4777
www.reedrubberproducts.com

Popular Glazing System Combinations

This section illustrates several gasket combinations common to storefront, curtainwall and residential glazing.

There are many considerations in choosing the correct design. This is only intended to be used as a guide highlighting the features and benefits of the various gasket choices.

Call our Customer Service Department and we will help you choose the right combination of gaskets for your system.

Foam Tape & Wedge

Features: AAMA approved Reedseal glazing tape is applied to one side of the glass. A wedge is then pushed into the opposite side to create sealing pressure. Proper sealing is achieved when the foam tape is compressed 25%. We can help you choose the right gasket combination for your system.

Benefits: The foam tape is closed cell and resists water. The wedge provides ample sealing pressure and a rain slope to let water flow away. This system is recommended for storefront and residential glazing.

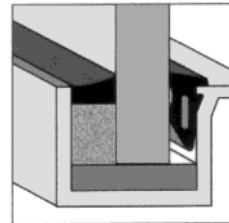

Preset & Wedge

Features: The preset is a cellular TPV and is either pushed in or slid through the track or race member of the window. A wedge in 65-70 durometer hardness is then pushed in to create the pressure seal.

Benefits: This system is easy to install in a “shop” or “field” environment. Our presets and wedges are designed to fit a wide variety of face clearances.

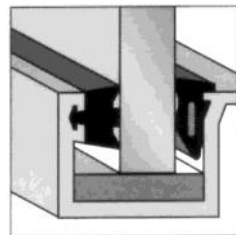

Preset & Spacer Wedge

Features: This is similar to the preset and wedge combination only silicone caulk is applied to create a structural seal over a silicone compatible TPV wedge (See SW series wedges) Samples are available for silicone compatibility testing.

Benefits: The spacer wedge provides a back up for the silicone caulk and creates a uniform depth of the silicone bead. Also helps keep cost of silicone down.

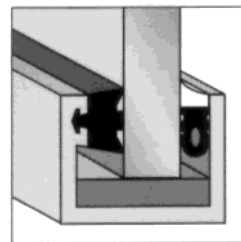



Phone: 314-450-4789
Fax: 314-450-4777
www.reedrubberproducts.com

Popular Glazing System Combinations

Foam Tape & Spacer Preset (both with cap bead)

Features: Reedseal foam tape is applied to window frame and preset loaded glazing bead snaps into place to create proper sealing pressure. Both seals are then cap beaded.

Benefits: Adhesive tape will allow for more handling and shifting while silicone cures over a uniform depth created by the preset and tape (consult silicone supplier for proper depth of silicone bead).

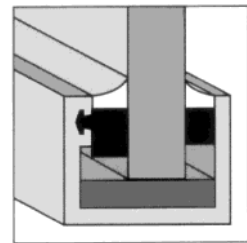

Preset & Foam Tape

Features: Reedseal foam tape is applied to the window frame and the preset is either pushed in or slid through the race of the opposing frame. The window frames are then snapped together to create the seal.

Benefits: Easily installed and affordable, the 1700 series foam tape is most popular with residential window manufacturers.

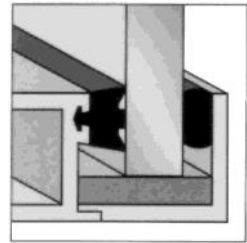

Spacer Preset & Spacer Wedge

Features: This system calls for the preset spacer to be pushed into the race and then the spacer wedge is installed to create the desired spacing on both sides of the glass. Both seals are then cap beaded with silicone. (Samples are available for silicone compatibility testing).

Benefits: This method of glazing prepares the window to be silicone caulked providing superior UV resistance and uniform depth of the silicone bead (contact your silicone supplier for proper depth of bead).

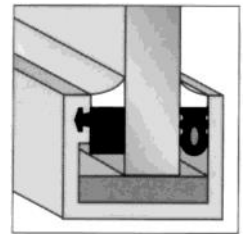



3901 Union Blvd Suite 106
St. Louis, MO 63115

Phone: 314-450-4789
Fax: 314-450-4777

www.reedrubberproducts.com



glazing seals, tapes,
and
setting blocks