

The logo for Reed Rubber Products is centered at the top, featuring the company name in a serif font within a white oval. Below the oval, the word 'PRODUCTS' is written in a spaced-out, sans-serif font. The background of the entire cover is a grayscale photograph of a modern building's glass facade, with various rubber glazing components like gaskets and spacers visible in the foreground.

Reed Rubber

P R O D U C T S

***Rubber Glazing
Components
Catalog***

Effective January 2012

314-450-4789

www.reedrubberproducts.com



314-450-4789

Table of Contents

Storefront gaskets	1-5
Curtainwall gaskets	6-7
Silicone Compatible wedges and presets	8
LB Plastics Glazing Seals	9
Glazing components for common Storefront systems	10
Glazing pocket details	11
Anti-walk spacers (“W” spacers)	12
Setting Blocks	12-14
Glazing tape	15
Structural mounting tape	16
Popular glazing system combinations	16-17



314-450-4789



VOLUME DISCOUNTS
 Effective February 1st, 2011

\$2000 order*
3% discount

\$5000 order*
6% discount

*Products can be combined to achieve discount

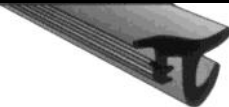
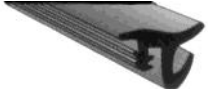
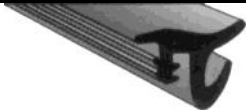
Storefront Gaskets

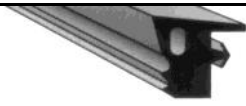
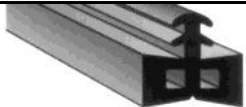
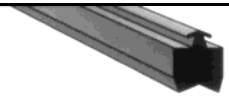
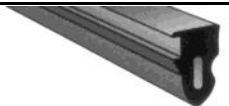
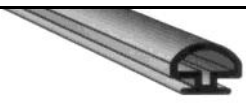
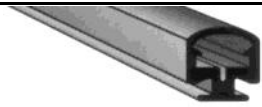
Reed Part #	Profile Not to scale	Conversion Part #	Ft./box	Price/ft
3678		Kawneer 27-074	500	.143
3679		Kawneer 27-076	500	.145
3680		Kawneer 27-077	Minimum Order 5,000	.218
3681		Kawneer 27-850	400	.278
3682		Kawneer 27-852	Minimum Order 5,000	.510
3683		Kawneer 162-310	250	.350
3684		Kawneer 27-857	500	.224
3661		Kawneer 27-810	1,000	.156
3662		Kawneer 27-807	500	.135
3663		Kawneer 27-808	500	.200



314-450-4789





VOLUME DISCOUNTS
 Effective February 1st, 2011

\$2000 order*
3% discount

\$5000 order*
6% discount

*Products can be combined to achieve discount

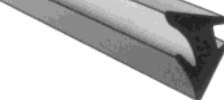
Storefront Gaskets

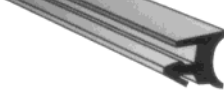
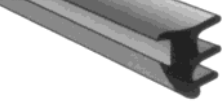
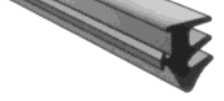
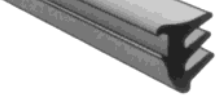
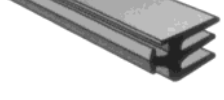
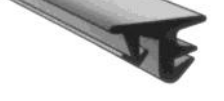
Reed Part #	Profile Not to scale	Conversion Part #	Ft./box	Price/ft
3654		Kawneer 27-222	1,000	.151
3656		Kawneer 27-285	1,000	.151
3657		Kawneer 27-200	500	.202
3730		Kawneer 27-221	1,000	.128
3731		Kawneer 27-223	1,000	.133
3696		Amarlite 05429	500	.170
3697		Amarlite 05430	500	.161
3698		Amarlite 05421	500	.140
3699		Amarlite 05212	500	.145
3685		Amarlite 05150	Minimum Order 5,000	.234



314-450-4789



VOLUME DISCOUNTS
 Effective February 1st, 2011

\$2000 order*
3% discount

\$5000 order*
6% discount

*Products can be combined to achieve discount

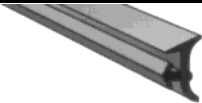
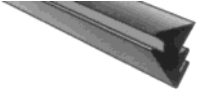
Storefront Gaskets

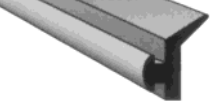
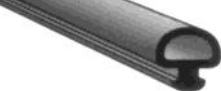
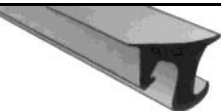
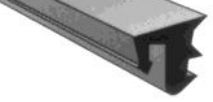
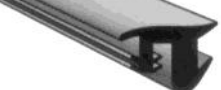
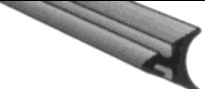
Reed Part #	Profile Not to scale	Conversion Part #	Ft./box	Price/ft
3737		US Alum. NP-150	1,000	.100
3738		US Alum. NP-260	1,000	.120
3686		US Alum. NP-225	500	.208
3734		Atlas 90	500	.160
3735		Atlas 67	1,000	.145
3694		Tubelite P-302	1,000	.104
3695		Tubelite P-528	500	.220
4893		Vistawall FG-1133	500	.190
3736		PPG 17-004-6300	500	.160
3748		Cronstrom A-2053	Minimum Order 5,000	.145



314-450-4789



VOLUME DISCOUNTS
Effective February 1st, 2011

\$2000 order*
3% discount

\$5000 order*
6% discount

*Products can be combined to achieve discount

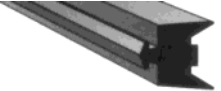
Storefront Gaskets

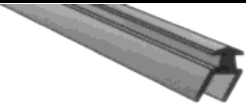
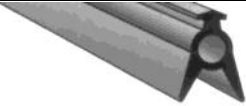
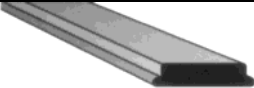
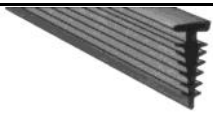
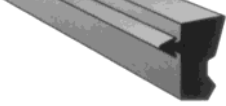
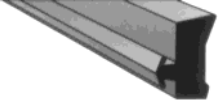
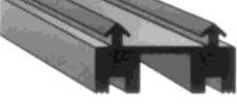
Reed Part #	Profile <small>Not to scale</small>	Conversion Part #	Ft./box	Price/ft
4001		Bonnell BTF-1400	1,000	.121
4002		Bonnell BTF-1400	500	.250
4004		Bonnell BTF-1400	Minimum Order 5,000	.187
4006		Bonnell BTF-400.1400	Minimum Order 5,000	.104
4007		Bonnell BTF-400,1400	Minimum Order 5,000	.184
3999		Bonnell BTF-400, 1400	1,000	.155
4990		Vision Strip	1,000	.156
3674		Keymark PW-251	Minimum Order 5,000	.244
3675		Keymark, PW-251 Kawneer 27-815	500	.230
1447		Keymark, PW-251 Kawneer 27-815	Minimum Order 5,000	.300



314-450-4789

VOLUME DISCOUNTS
 Effective February 1st, 2011

\$2000 order*
3% discount

\$5000 order*
6% discount

*Products can be combined to achieve discount

Storefront Gaskets

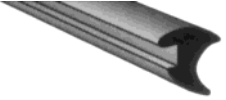
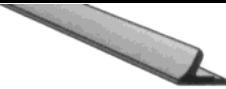
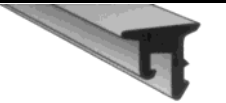
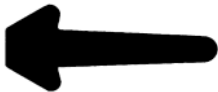
Reed Part #	Profile Not to scale	Conversion Part #	Ft./box	Price/ft
4020		YKK E2-0052	500	.187
4010		Winco H-11-28	Minimum Order 5,000	.151
4157		Elward 138G	Minimum Order 10,000	.083
4021		H63A	Minimum Order 5,000	.208
1152		Pivot Window Wipe	Minimum Order 4,000	.187

Glazing Gaskets are available in colors
 Call for pricing and minimums

Don't see the gasket you need?

We offer custom profiles manufactured in single, dual and tri-durometers. We can also extrude a thin "slip coat" layer to make the gasket easier to apply.

Call us for details



314-450-4789



VOLUME DISCOUNTS
Effective February 1st, 2011

\$2000 order*
3% discount

\$5000 order*
6% discount

*Products can be combined to achieve discount

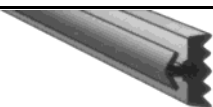
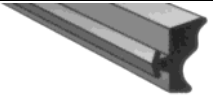
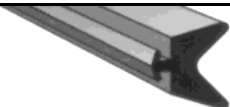
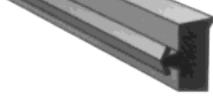
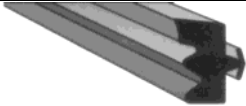
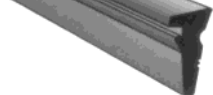
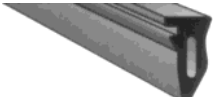
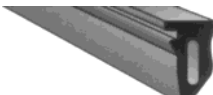
Curtainwall Gaskets

Reed Part #	Profile <small>Not to scale</small>	Critical Dimensions	Ft./box	Price/ft
B090 (sponge)		.125 face clearance, .250 centerline	500	.136
B109 (sponge)		.150 face clearance .250 centerline	500	.144
B115 (sponge)		PPG 70-810-66300 .250 face clearance .187 centerline	500	.234
B116		PPG 70-810-6300 .200 face clearance .250 centerline	500	.182
B140 (sponge)		.250 face clearance .250 centerline	500	.203
W513		.125 face clearance .062 nub	1,000	.125
W514		.187 face clearance .062 nub	500	.140
W516		.250 face clearance .062 nub	500	.215
W520		.350 face clearance .062 nub	500	.320



314-450-4789

VOLUME DISCOUNTS
 Effective February 1st, 2011

\$2000 order*
3% discount

\$5000 order*
6% discount

*Products can be combined to achieve discount

Curtainwall Gaskets

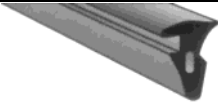
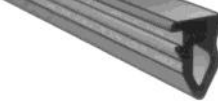
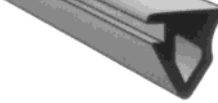
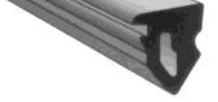
Reed Part #	Profile <small>Not to scale</small>	Critical Dimensions	Ft./box	Price/ft
W190		.187 face clearance .125 nub	500	.135
W250		.250 face clearance .125 nub	500	.200
W315		.312 face clearance .125 nub	500	.270
W375		.375 face clearance .100 nub	500	.312

Glazing Gaskets are available in colors

Call for pricing and minimums

Don't see the gasket you need?

We offer custom profiles manufactured in single, dual and tri-durometers. We can also extrude a thin "slip coat" layer to make the gasket easier to apply.

Call us for details



314-450-4789

VOLUME DISCOUNTS
 Effective February 1st, 2011

\$2000 order*
3% discount

\$5000 order*
6% discount

*Products can be combined to achieve discount

Silicone Compatible Wedges and Presets

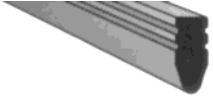
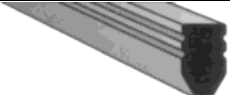
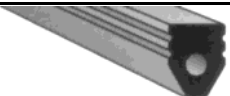
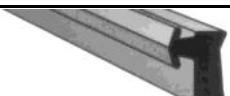
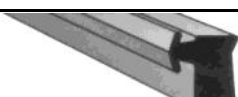
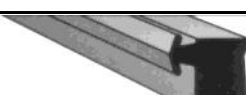
Reed Part #	Profile Not to scale	Critical Dimensions	Ft./box	Price/ft
SW125		.125 Face clearance	1,000	.140
SW187		.187 face clearance	500	.150
SW250		.250 face clearance	500	.250
SP125		.125 face clearance	Minimum Order 4,000	.200
SP187		.187 face clearance	Minimum Order 4,000	.230
SP250		.250 face clearance	Minimum Order 2,500	.400

Available in colors
 and
 custom made to your specifications



314-450-4789

VOLUME DISCOUNTS
Effective February 1st, 2011

\$2000 order*
3% discount

\$5000 order*
6% discount

*Products can be combined to achieve discount

LB Plastics Glazing Seals

Reed Part #	Profile Not to scale	Description	Ft./box	Price/ft
LBP/1362		Glazing Gasket for 600 Series (Large Version)	500	.220
LBP/1620		Glazing Gasket for 600 Series (Small Version)	Minimum Order 5,000	.230
LBP/1375		Casement Sash Seal for 800 & 8100 Double Hung (1/4" OD)	1000	.130
LBP/1376		Casement Frame Seal for 800 Series	1000	.129
LBP/1376G		Casement Frame Seal for 50 Series	Minimum Order 5,000	.160
LBP/1439		Casement Gasket for Series 900 Patio Door	1000	.190
LBP/1407		Bulb Seal for Series 500 Sash 9" Sill	500	.140
LBP/1611		Sash Seal for Series 67 window 6" Sill	500	.150
LBP/1267		Frame Seal for Garden Window Series 50-70-8600	1000	.130
LBP/1268		SW-7065 Glazing Spline for Garden Window Series 50-70-8600	Minimum Order 5,000	.110
LBP/1408		SW-7008 Series 50-70-8600	1000	.150



Phone: 314-450-4789
 Fax: 314-450-4777
www.reedrubberproducts.com

Bonnell Metal Systems

This section lists the common storefront metal systems produced by Wm. L. Bonnell Co.

BONNELL METAL SYSTEM	REED RUBBER PRODUCTS COMPONENTS
SD-30 (BTF-300, 450, 600)	3654 roll-in with 1/4" x 1/2" glazing tape 4005 mullion "U" channel, 4006 wiper gasket
SD-49 (BCE-250)	B116 exterior preset with B-1 15 interior preset. Alternate: B140 both sides.
SD-53 (BCE-850)	3654 roll-in with 3733 preset.
SD-58 (BCE-200)	B109 both interior and exterior with 3999 thermal separator.
SD-59 (A-9200)	3654 roll-in with 3656 preset.
SD-62 (BCE-1300)	3694 bead or exterior, 3739 fixed or interior.
SD-66 (BTF-700)	3734 both sides/head and sill with RU5100 mullion spacer tape.
SD-67 (BCE-100)	3730 roll-in with 3733 preset.
SD-71 (BCE-20)	3694 bulb seal on both sides.
SD-72 (BCE, 470, 480, 490)	3735 on both sides.
SD-102 (BCE-400)	3734 or 4893 both sides
SD-103 (BCE-450)	3734 or 4893 both sides
SO-104 (BCE-1400)	3734 or 4893 both sides
SD-106 (BCE-1450, 5450, 6450)	3734 or 4893 both sides
SD-120 (BTF-1400)	3654 roll-in, 4001 preset (horizontal) 4002, 4005, 4006 & 4007(vertical)
SD-118 (BCE-1100, 1150, 2150)	3696 roll-in with 3697 preset
SD-127 (BTF-2400)	3734 or 4893 both sides
SD-128 (BTF-1700)	3667 both sides
SD-129 (BCE-1850,-9200 BTF-1850)	3678 both sides, 3679 for oversized glass/3680 for undersized glass.
SD-139 (BCE-4000, -4500)	3695 both sides
SD-142 (BCE-1200,-2200)	1596 both sides
SD-156 (BCE-6200)	3654 & 3656

Keymark Metal Systems

This section lists the common storefront metal systems produced by Keymark Aluminum.

KEYMARK METAL SYSTEM	REED RUBBER COMPONENTS
PW251	3674 (interior) 3675 (exterior) 1447 thermal separator
450	3678 both sides



Phone: 314-450-4789
 Fax: 314-450-4777
www.reedrubberproducts.com

Suggested Glazing Pocket Details

What is the *nub dimension*? In order for the wedge to fit properly and lock into the metal, we will need to know this critical dimension on your metal. Here are some typical nubs:

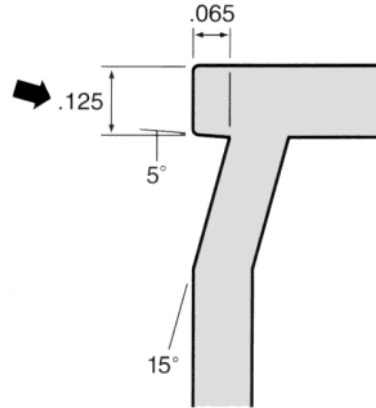
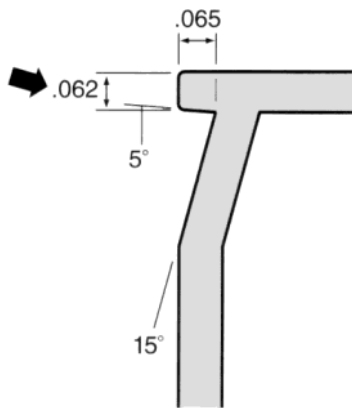

What is *face clearance*? Face clearance is the distance between the glass and the metal that our wedge or preset fills in a compressed state.

Here is an example:

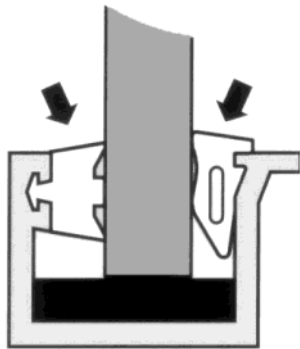

What is *centerline*? This dimension when associated with presets, measures from the center of the dart and race to the top of the metal.

Here is an example:

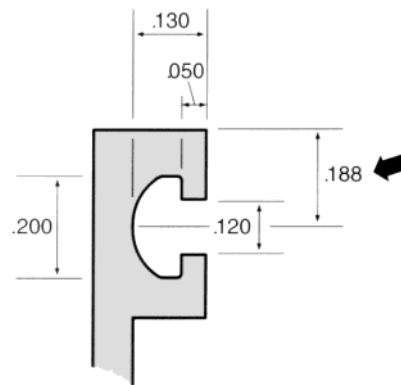

Durometer: This is the relative hardness of rubber as typically measured on the Shore A Scale for dense rubber. Generally Storefront Rubber falls in the 65-70 durometer range while setting block are 85 +/- 5 durometer.



Phone: 314-450-4789
 Fax: 314-450-4777
www.reedrubberproducts.com

Anti-Walk Side Spacers (“W” Spacers)

Anti-Walk or “*W*” *Spacers* are used on the perimeter of storefront glass to prevent “*walking*” due to vibration, temperature and wind variation. Glass to metal contact leads to breakage and subsequent air and water leakage. The *Anti-Walk* or “*W*” *Spacer* is self supporting and prevents this from happening. Simply follow these instructions:

- 1) Cut the *Anti-Walk* or “*W*” *Spacer* to a length that considers the depth of your pocket minus the “bite” of the glass minus 1/8”.
- 2) Slip “*W*” *Spacer* past glass bite.
- 3) The “*W*” *Spacer* will then assume a “locked” position.

Part #	1/2”	5/8”	3/4”	7/8”	1”	1 1/8”
BW3106	.210	.256	.300	.346	.392	.437

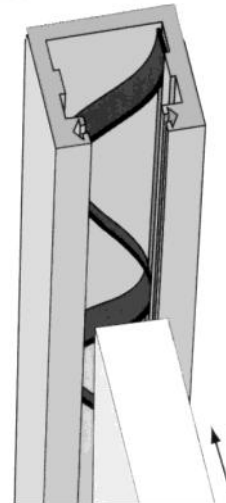

Setting Blocks

Neoprene Setting Blocks

**See next page for pricing and availability*

TPV Setting Blocks

Are frequently used with Lexan in Security Glazing, Photovoltaic Solar panels and other composite glass applications. Our TPV Setting Blocks are compatible with Lexan and will not cause crazing.

**Please call for pricing and availability*

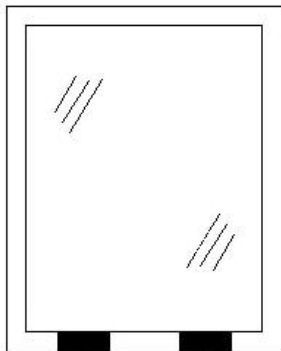

Setting Blocks centered at 1/4 points of glass.

Suggested Block Length per block:
 .1” per sq. ft. glass area but never less than 4”
 if glass width is greater than 48”.

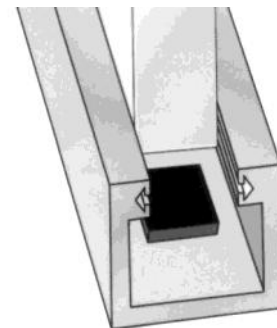

VOLUME DISCOUNTS

Effective February 1st, 2011

\$2000 order*
 3% discount

\$5000 order*
 6% discount

**Products can be combined to achieve discount*



Phone: 314-450-4789
 Fax: 314-450-4777
 www.reedrubberproducts.com

80 - 85 Durometer Neoprene Setting Blocks

2" long setting blocks				4" long setting blocks			
Size (in.)	Reed Part #	Qty/box	Price/hundred	Size (in.)	Reed Part #	Qty/box	Price/hundred
1/16 x 1/2 x 2	BN01082	1000	2.37	1/16 x 1/2 x 4	BN01084	1000	4.44
1/16 x 3/4 x 2	BN01122	1000	2.82	1/16 x 3/4 x 4	BN01124	1000	5.36
1/16 x 1 x 2	BN01162	1000	3.51	1/16 x 1 x 4	BN01164	1000	6.39
1/16 x 1-1/8 x 2	BN01182	1000	3.80	1/16 x 1-1/8 x 4	BN01184	1000	6.73
1/16 x 1-1/4 x 2	BN01202	1000	3.95	1/16 x 1-1/4 x 4	BN01204	1000	7.27
1/8 x 1/2 x 2	BN02082	1000	3.30	1/8 x 1/2 x 4	BN02084	1000	6.00
1/8 x 3/4 x 2	BN02122	1000	4.23	1/8 x 3/4 x 4	BN02124	1000	7.70
1/8 x 1 x 2	BN02162	1000	5.32	1/8 x 1 x 4	BN02164	1000	9.19
1/8 x 1-1/8 x 2	BN02182	1000	5.96	1/8 x 1-1/8 x 4	BN02184	1000	10.35
1/8 x 1-1/4 x 2	BN02202	1000	6.23	1/8 x 1-1/4 x 4	BN02204	1000	11.25
3/16 x 1/2 x 2	BN03082	1000	4.11	3/16 x 1/2 x 4	BN03084	1000	7.48
3/16 x 3/4 x 2	BN03122	1000	5.59	3/16 x 3/4 x 4	BN03124	1000	10.32
3/16 x 1 x 2	BN03162	1000	6.99	3/16 x 1 x 4	BN03164	1000	12.91
3/16 x 1-1/8 x 2	BN03182	1000	7.62	3/16 x 1-1/8 x 4	BN03184	1000	14.14
3/16 x 1-1/4 x 2	BN03202	1000	8.37	3/16 x 1-1/4 x 4	BN03204	1000	15.54

*Items in **bold** denote stock items. Please allow two weeks for other items.*

*Orders for non-stock setting blocks may be subject to +/- 10% on quantity

VOLUME DISCOUNTS Effective February 1st, 2011	\$2000 order* 3% discount
	\$5000 order* 6% discount
<small>*Products can be combined to achieve discount</small>	



Phone: 314-450-4789
 Fax: 314-450-4777
www.reedrubberproducts.com

80 - 85 Durometer Neoprene Setting Blocks

2" long setting blocks				4" long setting blocks			
Size (in.)	Reed Part #	Qty/box	Price/hundred	Size (in.)	Reed Part #	Qty/box	Price/hundred
1/4 x 1/2 x 2	BN04082	2000	5.21	1/4 x 1/2 x 4	BN04084	1000	9.41
1/4 x 3/4 x 2	BN04122	1000	7.27	1/4 x 3/4 x 4	BN04124	1000	13.00
1/4 x 1 x 2	BN04162	1000	8.97	1/4 x 1 x 4	BN04164	500	16.55
1/4 x 1-1/8 x 2	BN04182	500	9.74	1/4 x 1-1/8 x 4	BN04184	500	18.06
1/4 x 1-1/4 x 2	BN04202	500	10.70	1/4 x 1-1/4 x 4	BN04204	500	20.04
3/8 x 1/2 x 2	BN06082	500	7.10	3/8 x 1/2 x 4	BN06084	500	13.55
3/8 x 3/4 x 2	BN06122	500	10.12	3/8 x 3/4 x 4	BN06124	500	18.85
3/8 x 1 x 2	BN06162	500	12.98	3/8 x 1 x 4	BN06164	500	24.26
3/8 x 1-1/8 x 2	BN06182	500	14.22	3/8 x 1-1/8 x 4	BN06184	500	27.16
3/8 x 1-1/4 x 2	BN06202	500	15.55	3/8 x 1-1/4 x 4	BN06204	500	30.77
1/2 x 1/2 x 2	BN08082	500	9.30	1/2 x 1/2 x 4	BN08084	500	16.69
1/2 x 3/4 x 2	BN08122	500	12.94	1/2 x 3/4 x 4	BN08124	500	24.39
1/2 x 1 x 2	BN08162	500	16.91	1/2 x 1 x 4	BN08164	250	31.87
1/2 x 1-1/8 x 2	BN08182	250	19.07	1/2 x 1-1/8 x 4	BN08184	250	35.72
1/2 x 1-1/4 x 2	BN08202	250	20.44	1/2 x 1-1/4 x 4	BN08204	250	38.69

*Items in **bold** denote stock items. Please allow two weeks for other items.*

*Orders for non-stock setting blocks may be subject to +/- 10% on quantity

VOLUME DISCOUNTS Effective February 1st, 2011	\$2000 order* 3% discount \$5000 order* 6% discount
<small>*Products can be combined to achieve discount</small>	



Phone: 314-450-4789
 Fax: 314-450-4777
www.reedrubberproducts.com

Reedseal Glazing Tape

Reedseal black cross-linked polyethylene glazing tape meets requirements for AAMA 810.1 Type 1.

Reedseal has solvent based acrylic pressure sensitive adhesive on both sides for quick tack and long lasting adhesion.



Reedseal is very conformable and will adhere to a wide variety of surfaces making it an excellent material to seal out air and moisture in glazing applications.

Part Number	Thickness/Width/Length	Ft. Per Box	List Price (Per Ft.)
TY04-01062B	1/16" x 3/8" x 185'	7,400	.043
TY04-01082B	1/16" x 1/2" x 185'	5,550	.058
TY04-02062B	1/8" x 3/8" x 75'	3,000	.070
TY04-02082B	1/8" x 1/2" x 75'	2,250	.090

***Please Call for pricing and lead time for sizes not listed above

VOLUME DISCOUNTS
 Effective February 1st, 2011

\$2000 order*
 3% discount

\$5000 order*
 6% discount

*Products can be combined to achieve discount



Phone: 314-450-4789
 Fax: 314-450-4777
www.reedrubberproducts.com

Mounting Tape

Structural Very High Bond Acrylic Mounting tape for attaching Muntin bars or Facia trim. Available in White, Black and Gray. Please call for size and pricing information.

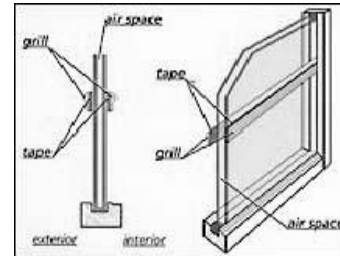

Popular Glazing System Combinations

This section illustrates several gasket combinations common to storefront, curtainwall and residential glazing. There are many considerations in choosing the correct design. This is only intended to be used as a guide highlighting the features and benefits of the various gasket choices. Call our Customer Service Department and we will help you choose the right combination of gaskets for your system.

Foam Tape & Wedge

Features: AAMA approved Reedseal 1700 series glazing tape is applied to one side of the glass. A wedge is then pushed into the opposite side to create sealing pressure. Proper sealing is achieved when the foam tape is compressed 25%. We can help you choose the right gasket combination for your system.

Benefits: The foam tape is closed cell and resists water. The wedge provides ample sealing pressure and a rain slope to let water flow away. This system is recommended for storefront and residential glazing.

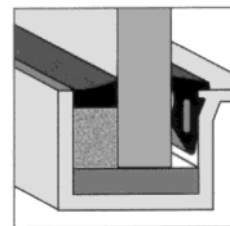

Preset & Wedge

Features: The preset is a cellular TPV and is either pushed in or slid through the track or race member of the window. A wedge in 65-70 durometer hardness is then pushed in to create the pressure seal.

Benefits: This system is easy to install in a “shop” or “field” environment. Our presets and wedges are designed to fit a wide variety of face clearances.

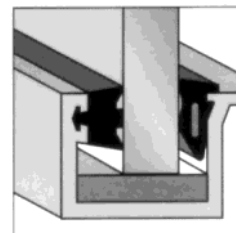



Phone: 314-450-4789
Fax: 314-450-4777
www.reedrubberproducts.com

Popular Glazing System Combinations

Preset & Spacer Wedge

Features: This is similar to the preset and wedge combination only silicone caulk is applied to create a structural seal over a silicone compatible TPV wedge (See SW series wedges) Samples are available for silicone compatibility testing.

Benefits: The spacer wedge provides a back up for the silicone caulk and creates a uniform depth of the silicone bead. Also helps keep cost of silicone down.

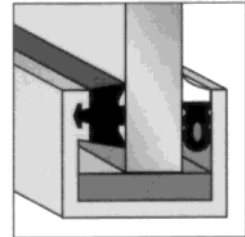

Foam Tape & Spacer Preset (both with cap bead)

Features: Reedseal 1700 series tape is applied to window frame and preset loaded glazing bead snaps into place to create proper sealing pressure. Both seals are then cap beaded.

Benefits: Adhesive tape will allow for more handling and shifting while silicone cures over a uniform depth created by the preset and tape (consult silicone supplier for proper depth of silicone bead).

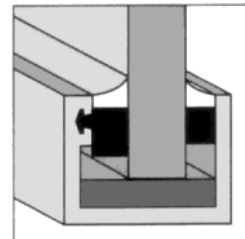

Preset & Foam Tape

Features: Reedseal 1700 series foam tape is applied to the window frame and the preset is either pushed in or slid through the race of the opposing frame. The window frames are then snapped together to create the seal.

Benefits: Easily installed and affordable, the 1700 series foam tape is most popular with residential window manufacturers.

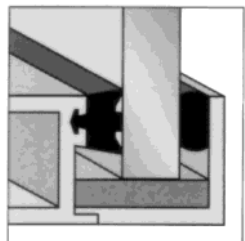

Spacer Preset & Spacer Wedge

Features: This system calls for the preset spacer to be pushed into the race and then the spacer wedge is installed to create the desired spacing on both sides of the glass. Both seals are then cap beaded with silicone. (Samples are available for silicone compatibility testing).

Benefits: This method of glazing prepares the window to be silicone caulked providing superior UV resistance and uniform depth of the silicone bead (contact your silicone supplier for proper depth of bead).

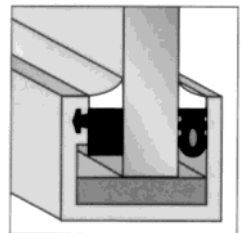



3901 Union Blvd Suite 150
St. Louis, MO 63115

Phone: 314-450-4789

Fax: 314-450-4777

www.reedruberproducts.com

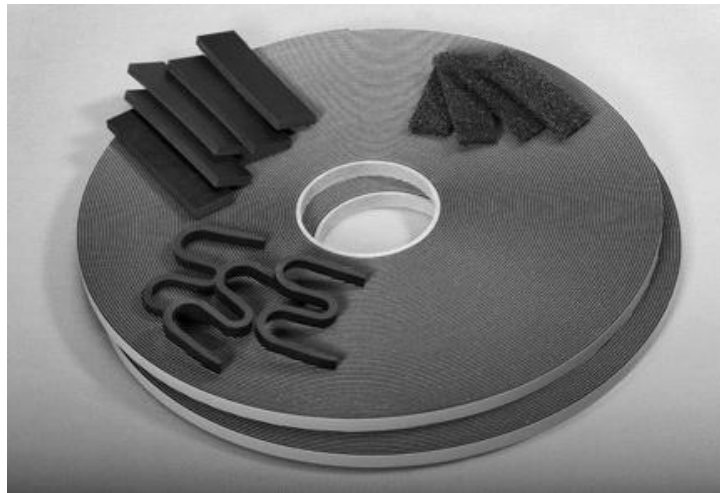

glazing seals, tapes
and
setting blocks